

# PATHFINDER

## Technical Specification

Product Code: OV10120BKCW

Description: 20W LED Floodlight IP65 CW Black

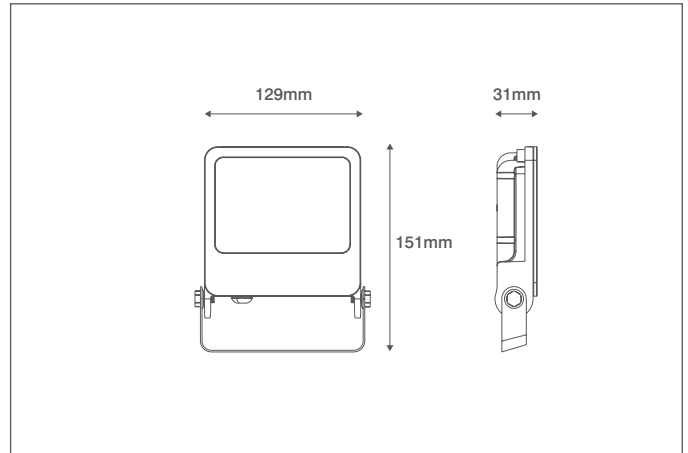

### General Information

Dimensions (mm)	129 (W) x 31 (D) x 151 (H)
Materials	Body: Powdercoated Aluminium; Diffuser: Prismatic Glass
Finish	Black (RAL 9004)
Product Weight (Kg)	0.39
Ingress Protection	IP65
Impact Rating (IK)	06
Warranty (Years)	3

### Supply & Power Information

Input Voltage & Frequency (V~ / Hz)	220-240 50/60
Safety Class	I
Circuit Wattage (W)	20
Input Current (mA)	46
Inrush Current/Time	0.047A (56µs)
Power Factor	0.9
Operating Temperature (°C)	-20 to +45
Critical Temperature (°C)	+70
Input Mains Cable	3 x 1mm <sup>2</sup> H05RN-F (1 Metre)

### Luminaire Output

Colour Temperature (K)	4000
Colour Render Index (CRI)	>80
Typical Luminous Flux (lm)	1600
Efficacy (lm/W)	80
Beam Angle (°)	110
LED Lifetime (L70) (Hours)	30000

### Dimming Information

Dimmable	No
----------	----

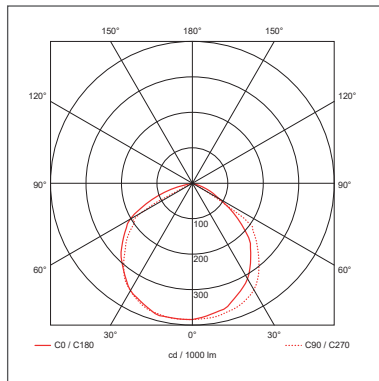

OVIA Limited, Scolmore House, Mariner, Lichfield Road Industrial Estate, Tamworth, Staffordshire, B79 7UL United Kingdom

T: +44 (0)1827 300640

E: sales@oviaUK.com | W: oviaUK.com

